

## Produktový list

### RotoQ Q4 – kyvné okno



#### Popis

- + kyvný spôsob otvárania – pánt v strede rámu
- + jednoduchá, bezpečná a rýchla montáž vďaka klik systému
- + madlo na hornej strane krídla pre pohodlné ovládanie
- + nastaviteľný pánt pre dodatočné nastavenie krídla voči rámu
- + bezpečnostná umývacia poloha
- + štrbinová ventilácia

#### Technické informácie

	Plast (K)	Drevo (H)
<b>Sklon strechy</b>	15°–79°	
<b>Materiál krídla a rámu</b>	vláknom vystužený viackomorový PVC profil s kovovou výstuhou	drevený profil z masívu borovica, lakovaný bezfarebným vodeodolným lakom, vodotesné lepenie
<b>Farva profilu</b>	plast v bielej farbe, odtieň najbližšej RAL 9016	borovica
<b>Kovanie a ovládanie</b>	kovanie s 3 bodovým uzamykaním s ovládacím ergonomickým madlom v hornej časti krídla	
<b>Umývacia poloha</b>	manuálne s bezpečnostnou poistkou proti pretočeniu	
<b>Vetranie</b>	štrbinové prevetrávanie	
<b>Madlo</b>	biela RAL 9016	šedá RAL 7004
<b>Tesnenie</b>	dvojité tesnenie krídla	
<b>Farba oplechovania a materiál</b>	hliníkové AL – farba Antrazit Metallic (R703), za príplatok: meď CU, titánzinok TV, RAL farba RL	

#### Funkcie



#### Vetranie

jednoducho a bezpečne



#### Komfortná údržba











bezpečnostná poistka





















\*Podrobné záručné podmienky nájdete na [www.roto-frank.com/cz/dst/zaruka](http://www.roto-frank.com/cz/dst/zaruka)



**Rozmery**

										
Označenie veľkostí	<b>055/078</b>	<b>055/098</b>	<b>055/118</b>	<b>066/098</b>	<b>066/118</b>	<b>066/140</b>	<b>078/078</b>	<b>078/098</b>	<b>078/118</b>	<b>078/140</b>
Vonkajší rozmer okna (mm)	550/774	550/974	550/1174	660/974	660/1174	660/1394	780/774	780/974	780/1174	780/1394
Vonkajší rozmer zatepl. rámu (mm)	610/834	610/1034	610/1234	720/1034	720/1234	720/1454	840/834	840/1034	840/1234	840/1454
Vnútorý rozmer ostenia (mm)	495/719	495/919	495/1119	605/919	605/1119	605/1339	725/719	725/919	725/1119	725/1339
Vonkajší rozmer krídla (mm)	467/688	467/888	467/1088	577/888	577/1088	577/1308	697/688	697/888	697/1088	697/1308
Vnútorý rozmer krídla (mm)	381/571	381/771	381/971	491/771	491/971	491/1191	611/571	611/771	611/971	611/1191
Plocha zasklenia (m <sup>2</sup> )	0,22	0,29	0,37	0,38	0,48	0,58	0,35	0,47	0,59	0,73

										
Označenie veľkostí	<b>078/160</b>	<b>078/180</b>	<b>094/078</b>	<b>094/098</b>	<b>094/118</b>	<b>094/140</b>	<b>094/160</b>	<b>094/180</b>	<b>114/078</b>	<b>114/098</b>
Vonkajší rozmer okna (mm)	780/1596	780/1796	942/774	942/974	942/1174	942/1394	942/1596	942/1796	1140/774	1140/974
Vonkajší rozmer zatepl. rámu (mm)	840/1656	840/1856	1002/834	1002/1034	1002/1234	1002/1454	1002/1656	1002/1856	1200/834	1200/1034
Vnútorý rozmer ostenia (mm)	725/1541	725/1741	887/719	887/919	887/1119	887/1339	887/1541	887/1741	1085/719	1085/919
Vonkajší rozmer krídla (mm)	697/1510	697/1710	859/688	859/888	859/1088	859/1308	859/1510	859/1710	1057/688	1057/888
Vnútorý rozmer krídla (mm)	611/1393	611/1593	773/571	773/771	773/971	773/1191	773/1393	773/1593	971/571	971/771
Plocha zasklenia (m <sup>2</sup> )	0,85	0,97	0,44	0,60	0,75	0,92	1,08	1,23	0,55	0,75

									
Označenie veľkostí	<b>114/118</b>	<b>114/140</b>	<b>114/160</b>	<b>114/180</b>	<b>134/78</b>	<b>134/98</b>	<b>134/118</b>	<b>134/140</b>	<b>134/160</b>
Vonkajší rozmer okna (mm)	1140/1174	1140/1394	1140/1596	1140/1796	1340/774	1340/974	1340/1174	1340/1394	1340/1596
Vonkajší rozmer zatepl. rámu (mm)	1200/1234	1200/1454	1200/1656	1200/1856	1400/834	1400/1034	1400/1234	1400/1454	1400/1656
Vnútorý rozmer ostenia (mm)	1085/1119	1085/1339	1085/1541	1085/1741	1285/719	1285/919	1285/1119	1285/1339	1285/1541
Vonkajší rozmer krídla (mm)	1057/1088	1057/1308	1057/1510	1057/1710	1257/688	1257/888	1257/1088	1257/1308	1257/1510
Vnútorý rozmer krídla (mm)	971/971	971/1191	971/1393	971/1593	1171/571	1171/771	1171/971	1171/1191	1171/1393
Plocha zasklenia (m <sup>2</sup> )	0,94	1,16	1,35	1,55	0,67	0,90	1,14	1,39	1,63

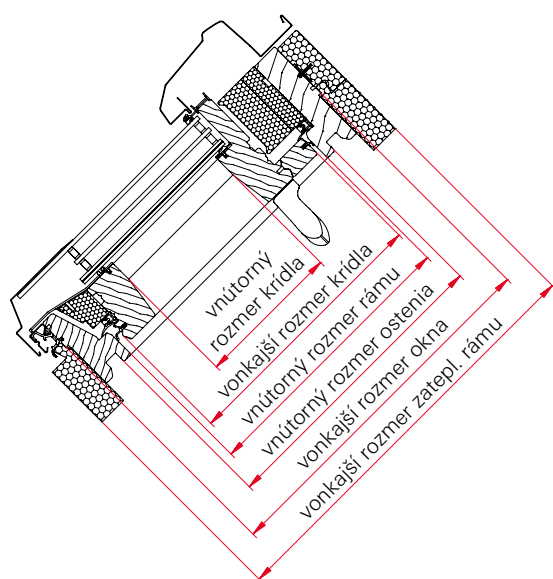
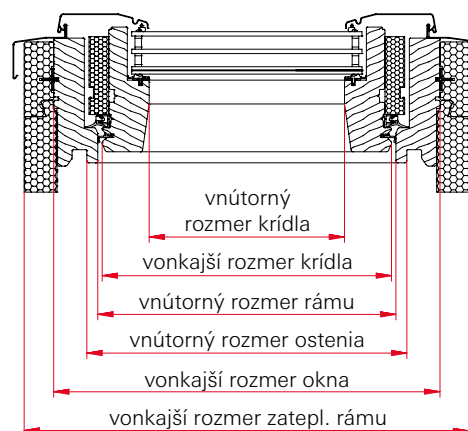
**rez A-A**

**rez B-B**

## Technické parametre

Typ okna	Názov zasklenia	U <sub>w</sub> – okna s WD (W/m <sup>2</sup> K) DIN EN ISO 10077, DIN EN ISO 12567-2	U <sub>g</sub> – skla (W/m <sup>2</sup> K) DIN EN 673	Hlukový útlm EN ISO 20140-3, EN ISO 717-1	g (%) DIN EN 410	Tv (%) DIN EN 410	Zasklenie VSG = lepené bezpečnostné sklo ESG = kalené bezpečnostné sklo TVG = tepelne spevnené sklo
Q42S K	dvojsklo Standard	1,1	1,0	33 (-1;-4) dB	52	72	ESG4/16/4
Q42S H	dvojsklo Standard	1,1	1,0	33 (-1;-4) dB	52	72	
Q42C K	dvojsklo Comfort	1,1	1,0	37 (-2;-5) dB	51	71	ESG4/16/VSG6
Q42C H	dvojsklo Comfort	1,1	1,0	37 (-1;-5) dB	51	71	
Q43C K	trojsklo Comfort	0,90	0,7	38 (-2;-6) dB	44	61	ESG4/12/ESG4/12/VSG6
Q43C H	trojsklo Comfort	0,90	0,7	38 (-2;-5) dB	44	61	
Q43P K	trojsklo Premium	0,77	0,5	38 (-1;-5) dB	45	61	ESG4/12/ESG4/12/VSG6
Q43P H	trojsklo Premium	0,77	0,5	38 (-2;-5) dB	45	61	
Q43A K	trojsklo Acoustic	0,78	0,5	44 (-2;-6) dB	43	63	VSG8/10/ESG4/10/VSG6
Q43A H	trojsklo Acoustic	0,78	0,5	42 (-2;-5) dB	43	63	

